

OnShape - Basics of Sketching

Technical drawing

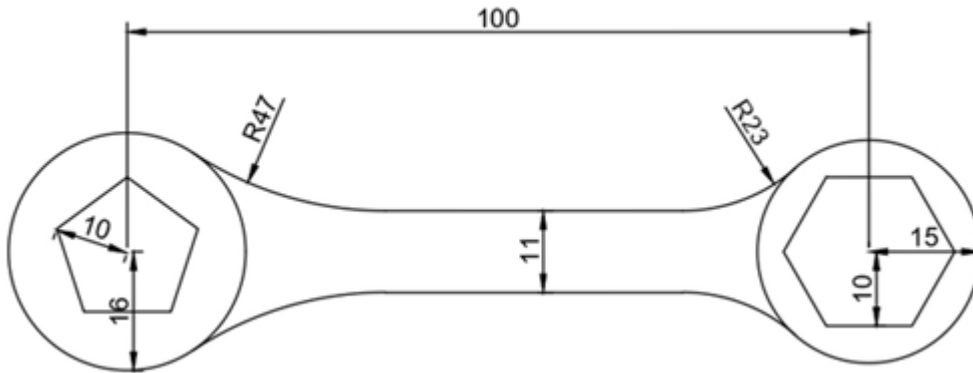

Expected 3D model

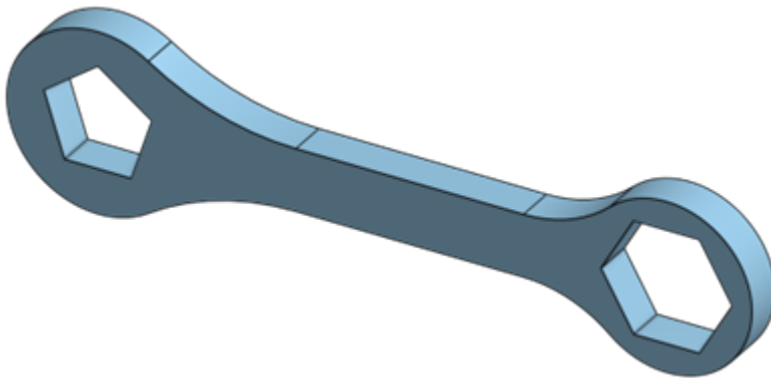

From: <https://edu.iit.uni-miskolc.hu/> - Institute of Information Science - University of Miskolc

Permanent link: https://edu.iit.uni-miskolc.hu/tanszek:oktatas:techcomm:sketching_-_simple_wrench_example?rev=1759144399

Last update: 2025/09/29 11:13

