

# OnShape - Basics of Sketching

## Technical drawing

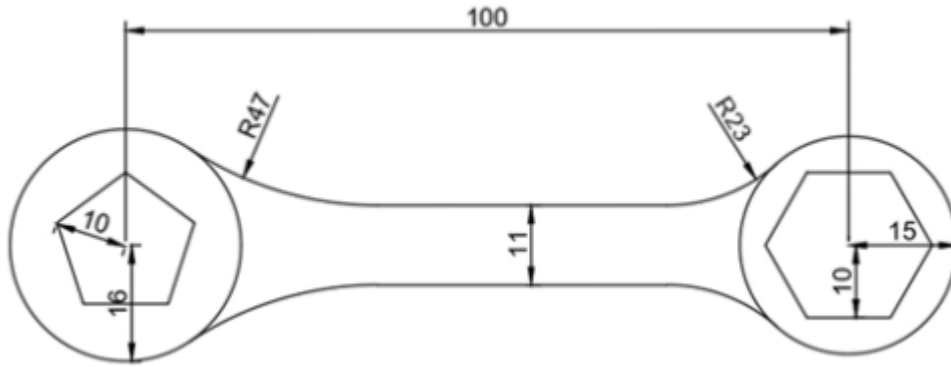

## Target 3D model

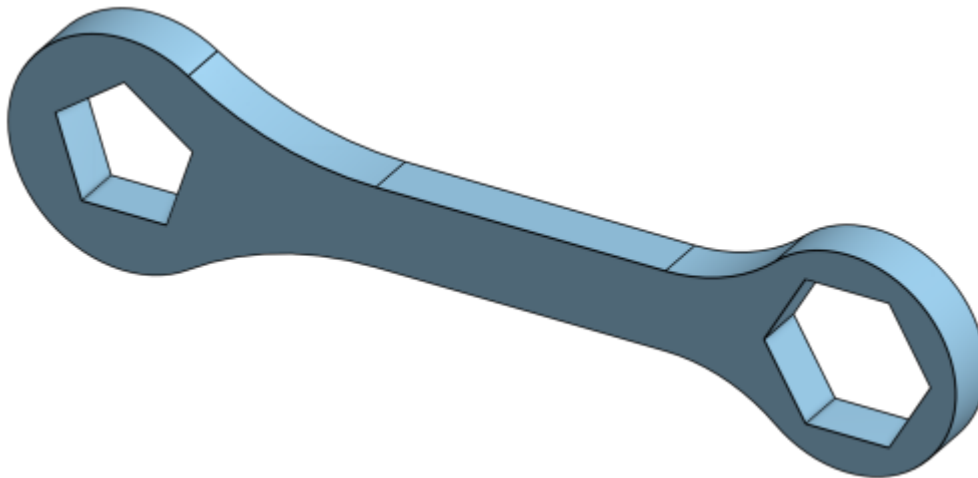

From: <https://edu.iit.uni-miskolc.hu/> - Institute of Information Science - University of Miskolc

Permanent link: [https://edu.iit.uni-miskolc.hu/tanszek:oktatas:techcomm:sketching\\_-\\_simple\\_wrench\\_example?rev=1759144474](https://edu.iit.uni-miskolc.hu/tanszek:oktatas:techcomm:sketching_-_simple_wrench_example?rev=1759144474)

Last update: 2025/09/29 11:14

